

EN DuoFern Universal Actuator 9470-1 (1-channel)
Instruction manual for the electrical connection and for commissioning

Item no. 3514 02 61

Type: 9470-1



1. This manual.....	3
1.1 How to use this manual	3
2. Hazard symbols.....	4
2.1 Levels of danger and signal words.....	4
2.2 Symbols and depictions used.....	5
3. Safety instructions.....	6
3.1 Intended use	6
3.2 Improper use.....	7
3.3 Expert knowledge required by the installer	8
3.4 Glossary - definition	8
4. Included in delivery.....	9
5. Overview and connections	10
5.1 Operating buttons and indicator light	11
6. Functional description.....	12
6.1 Functional characteristics.....	13
6.2 Description of the functions and parameters.....	15
7. Technical specifications	17
8. Connecting the DuoFern Universal Actuator 9470-1	20
8.1 Safety instructions for the electrical connection.....	20
8.2 Important information regarding the electrical connection.....	22
8.3 Connecting and installing the DuoFern Universal Actuator 9470-1	23
8.4 Connection diagram	24
8.5 Installation example.....	25
9. Logging DuoFern transmitters on / off.....	26
9.1 Logging on and off via radio code	27
10. Deleting all settings (reset).....	28
11. Dismantling	28
12. Simplified EU declaration of conformity	29

...describes how to install, connect and commission the DuoFern Universal Actuator 9470-1.

1.1 How to use this manual

- ◆ Before you begin, please read this manual through completely and follow all the safety instructions.
- ◆ Please also read the instruction manuals of the accessories, if available, as well as the instructions of the respective connected appliance.
- ◆ This manual is part of the product. Please store it in an easily accessible place.
- ◆ When passing the DuoFern Universal Actuator 9470-1 on to a third party, this manual must be passed on as well.
- ◆ Damage resulting from non-compliance with this manual and the safety instructions will void the warranty. We assume no liability for any consequential damage.

The following hazard symbols are used in this manual:



Danger to life resulting from electric shock



Danger area / dangerous situation

2.1 Levels of danger and signal words

 **DANGER!**

This hazard will lead to serious injury or death if not avoided.

 **WARNING!**



This hazard may result in serious injury or death if not avoided.

 **CAUTION!**

This hazard may result in minor or moderate injury if not avoided.

 **ATTENTION!**

This hazard may lead to property damage.

Depiction	Description
1.	Procedures
2.	
◆	Itemisation
1) or a)	Lists
	Further useful information
	Please read the respective manual



The use of defective devices can lead to personal injury and damage to property (electric shock / short circuit).

- ◆ Never use defective or damaged devices.
- ◆ Check that the DuoFern Universal Actuator 9470-1 is intact.
- ◆ Consult our customer service department in the event that you discover damage.

3.1 Intended use

Only use the DuoFern Universal Actuator 9470-1 for connecting and controlling electrical appliances (e.g. lighting) within the permissible load limits, see “Technical Specifications”.

The DuoFern Universal Actuator 9470-1 is suitable for connecting the mains voltage and extra-low voltage (ELV) with basic insulation.

Operating conditions

- ◆ Only use the DuoFern Universal Actuator 9470-1 in dry rooms.
- ◆ A 230 V / 50 Hz power supply, together with a site-provided disconnecting device (fuse), must be available at the installation location.
- ◆ The installation and operation of the radio systems is only permitted for systems and devices where a malfunction in the transmitter or receiver would not cause a danger to persons or property or where this risk is already covered by other safety equipment.



3.1 Intended use

EN



Radio systems that transmit on the same frequency can cause interference.



3.2 Improper use

Using the DuoFern Universal Actuator 9470-1 for any other purpose than previously mentioned is not permissible.



Improper use can lead to serious injuries or property damage.

- ◆ Never use the DuoFern Universal Actuator 9470-1 to:
 - Disconnect the connected appliance
 - Connect the safety extra-low voltage (SELV)
- ◆ Never use the radio system (e.g. DuoFern radio system) and its components for the remote control of devices and systems with increased safety-relevant requirements or where there is an accident risk. Applications of this kind require additional safety equipment. Observe the respective statutory regulations for the installation of such systems.



There is a risk to life caused through short circuiting and electric shocks if the DuoFern Universal Actuator 9470-1 is used outside or in damp rooms.

- ◆ Do not install and use the DuoFern Universal Actuator 9470-1 outside or in damp rooms.

The electrical connection, installation and commissioning of the DuoFern Universal Actuator 9470-1 must only be carried out by a qualified electrician in accordance with the instructions in this manual.

DuoFern

- ◆ RADEMACHER radio technology for controlling compatible products

WR ConfigTool

- ◆ RADEMACHER software for programming the DuoFern Manual Control incl. automatic software updates for the DuoFern Manual Control

SmartHome Box

- ◆ The SmartHome Box is a central controller unit for RADEMACHER radio products

ELV

- ◆ Extra-low voltage

SELV





- ◆ Safety extra-low voltage

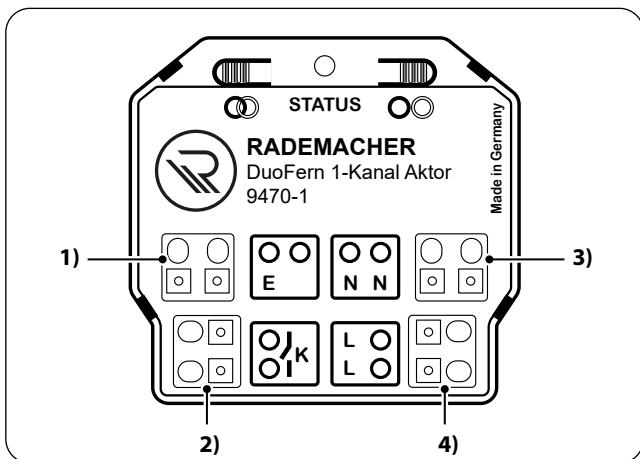

Included in delivery

- a) 1 x DuoFern Universal Actuator 9470-1 incl. antenna
- b) 1 x instruction manual (not illustrated)



Pos.	Symbol	Description
1)		Control input 230 V / 50 Hz \sim / (on / off) <i>Connection of an external switch / button for manual control on site</i>
2)		Relay contact [K] <i>Connection of an electrical appliance</i>
3)		Neutral conductor [N] <i>Connection of the neutral conductor</i>
4)		Supply voltage [L] 230 V / 50 Hz \sim <i>Connection of the supply voltage</i>

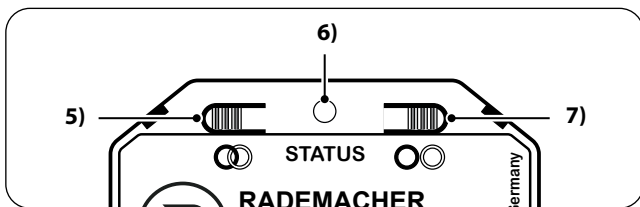

Pos.	Symbol	Description																		
5)		<p>Connect button</p> <p><i>Logging on to the DuoFern radio network or a DuoFern transmitter</i></p>																		
6)	STATUS	<p>Indicator light - status display</p> <hr/> <table border="0"> <tr> <td>green</td> <td><i>flashing</i></td> <td><i>Connection is active</i></td> </tr> <tr> <td></td> <td><i>constantly lit up</i></td> <td><i>Connection or disconnection was successful</i></td> </tr> <tr> <td></td> <td><i>brief flashing</i></td> <td><i>Control command received</i></td> </tr> </table> <hr/> <table border="0"> <tr> <td>red</td> <td><i>flashing</i></td> <td><i>Disconnection is active</i></td> </tr> <tr> <td></td> <td></td> <td><i>or The overload protection has switched off the actuator</i></td> </tr> <tr> <td></td> <td><i>permanently lit up</i></td> <td><i>Connection or disconnection was not successful</i></td> </tr> </table>	green	<i>flashing</i>	<i>Connection is active</i>		<i>constantly lit up</i>	<i>Connection or disconnection was successful</i>		<i>brief flashing</i>	<i>Control command received</i>	red	<i>flashing</i>	<i>Disconnection is active</i>			<i>or The overload protection has switched off the actuator</i>		<i>permanently lit up</i>	<i>Connection or disconnection was not successful</i>
green	<i>flashing</i>	<i>Connection is active</i>																		
	<i>constantly lit up</i>	<i>Connection or disconnection was successful</i>																		
	<i>brief flashing</i>	<i>Control command received</i>																		
red	<i>flashing</i>	<i>Disconnection is active</i>																		
		<i>or The overload protection has switched off the actuator</i>																		
	<i>permanently lit up</i>	<i>Connection or disconnection was not successful</i>																		
7)		<p>Disconnect button</p> <ul style="list-style-type: none"> ◆ <i>Logging off from the DuoFern radio network or a DuoFern transmitter</i> ◆ <i>Reset to the default factory settings</i> 																		

Controlling electrical appliances

With the DuoFern Universal Actuator 9470-1, you can connect and control electrical appliances (e.g. lighting, etc.) with up to a maximum of 3600 W.

Use in a DuoFern network

The DuoFern Universal Actuator 9470-1 can be integrated into a DuoFern network, for example, to use the range of functions of DuoFern sensors and DuoFern transmitters, such as the SmartHome Box.

Manual operation on site

An additional external switch / button can be connected to enable manual operation on site.

Installation and electrical connection

The DuoFern Universal Actuator 9470-1 is designed for flush mounting. The electrical connection is carried out by means of clamping the connecting cable in the existing spring clip.

Overload protection

When the DuoFern Universal Actuator 9470-1 is overloaded, it heats up and switches off. This state is indicated by the flashing red LED. It is not possible to switch on the connected appliance. The normal function is restored again by cooling down the actuator.



If the overload protection is triggered regularly, check whether the connected appliance lies within the technical specifications, see page 17 and whether the cable cross-sections are sufficient, see page 21 / 24.

DuoFern SmartHome Box									
DuoFern Environmental Sensor									
DuoFern Manual Control									
* WR ConfigTool with DuoFern Manual Control									
RolloTron Comfort DuoFern / Troll Comfort DuoFern									
DuoFern Manual Transmitter Standard									
DuoFern Wall Controller									
Function	Value range	Factory setting	A	B	C	D	E	F	G
1. Manual operation	On/Off/Dim	-	●	●			●		●
2. Unit / light mode	Unit / light mode	Light mode							●
3. Manual mode on / off	on / off	off				●	●		●
4. Automatic timer on / off	on / off	on				●	●		●
5. Random function	-	-			●		●		●
6. Dawn function	-	-			●		●	●	●
7. Automatic dawn function on / off	on / off	off				●	●		●
8. Automatic dusk function	-	-			●		●	●	●
9. Automatic dusk function on / off	on / off	off				●	●		●
10. Sun function	-	-			●			●	
11. Automatic sun function on / off	on / off	off				●	●		●

* The "WR ConfigTool" software can be downloaded from our website at www.rademacher.de.

DuoFern SmartHome Box										
DuoFern Environmental Sensor										
DuoFern Manual Control										
* WR ConfigTool with DuoFern Manual Control										
RolloTron Comfort DuoFern / Troll Comfort DuoFern										
DuoFern Manual Transmitter Standard										
DuoFern Wall Controller										
Function	Value range	Factory setting	A	B	C	D	E	F	G	
12. Connectivity test	-	-						•	•	
13. Connect with radio code	-	-				•	•		•	
14. Reset via radio (3-stage)	-	-				•			•	
15. Single-button operation	-	-								
16. Stairwell function	on / off	off				•			•	
17. Stairway time (pulse duration) ***	100 ms - 3276 s	3 minutes				•			•	

* The "WR ConfigTool" software can be downloaded from our website at www.rademacher.de.

*** Advanced switch-off warning for > 60 seconds and with uneven values

Light/device mode

By switching between the light and the device mode, the behaviour of the DuoFern Universal Actuator 9470-1 can be changed:

The range of functions changes as follows:

Switching commands of an external DuoFern transmitter	Device mode	Light mode
UP	On	Off
STOP	Off	Off
DOWN	Off	On
Dawn function	On	Off
Automatic dusk function	Off	On

Random function (presence simulation)

The DuoFern Universal Actuator 9470-1 can process random function switching commands. If a switching command is received which is to be delayed by the random function, then processing of the switching command is delayed by up to 30 minutes.

During the delay time, the indicator light on the DuoFern Universal Actuator 9470-1 flashes green every second.



- ◆ Automatic movement commands of the automatic sun function are **not** delayed.
- ◆ Automatic switching times and dusk commands are delayed.

Stairway function (on / off)

When the stairway function is active, the DuoFern Universal Actuator 9470-1 will switch off the controlled device again after the set "stairway time". An advanced switch-off warning for > 60 seconds and with uneven values can optionally be set.

Mains connection [L / N]





Mains supply voltage:	230 V / 50 Hz ~
Consumption:	Standby: < 0.5 W

Control input [E]

for an external manual switch / button on site

Input voltage:	230 V (Ri = 200 kΩ)
----------------	---------------------

Relay output - load contact [K]

Switching voltage:	230 V / 50 Hz ~	
Maximum switching capacity:	Ohmic load, e.g. bulbs	
		16 A / 3600 W
	Inductive loads such as: fluorescent lamps, drives, iron core transformers, e.g. for extra-low voltage bulbs such as halogen bulbs	
	 	8 A / 1800 W
		

Relay output - load contact [K]

Maximum switching capacity:

Capacitive loads such as: electronic transformers, AC/DC transformer, e.g. for extra-low voltage lamps such as halogen lamps, LEDs, etc.



8 A / 1800 W



Improper use can lead to serious injuries or property damage.

- ◆ Small contact distance (μ), not suitable for disconnecting the device.
- ◆ Do not use the DuoFern Universal Actuator 9470-1 to disconnect the connected appliance.

DuoFern radio technology

Transmission frequency:	434.5 MHz
Transmission power:	Max. 10 mW
Range:	Indoors: approx. 30 m * Outdoors: approx. 100 m <i>* Depending on the building structure</i>
Max. number of DuoFern devices:	20

General information	
Permissible ambient temperature range:	-20 °C to + 55 °C
Dimensions (W x H x D):	48.7 x 45.7 x 19.8 mm
Connecting terminals:	Spring resistance connecting terminals (0.1 mm ² - 1.5 mm ²) for solid conductors



8. Connecting the DuoFern Universal Actuator 9470-1

EN

Prior to the electrical connection, check that the voltage / frequency on the type plate corresponds to that of the local mains supply.



8.1 Safety instructions for the electrical connection



DANGER!

There is a risk of fatal electric shock when touching electrical components.

- ◆ All connection and installation work must only be carried out in a de-energised state.
- ◆ Disconnect all phases of the mains power lead and secure it to prevent any reconnection.
- ◆ Check that the system is de-energised.



WARNING!

Short-circuiting, caused when the DuoFern Universal Actuator 9470-1 is overloaded, poses a danger to life.

- ◆ The maximum switching capacity must not be exceeded. Please observe the details in the "Technical Specifications", see page 18.

**WARNING!**

There is a risk of short circuits and fire if the wrong connecting cable is used.

- ◆ Only use solid copper connecting cables with a cable cross-section of 1.5 mm² for connecting the electrical appliance.

**ATTENTION!**

A defective antenna can lead to malfunctions or failure of the DuoFern Universal Actuator 9470- 1.

- ◆ The antenna lead must not be shortened and damaged.

Connection instructions for operating with an external switch / button on site

- ◆ When using the control input [E], you must connect the external switch / button and the DuoFern Universal Actuator 9470-1 to the same phase [L].
- ◆ The maximum length of lead to connect an external button must not exceed 10 m.

Length of insulation stripped:



All leads must be stripped to 9 mm.



Read the specifications relating to the electrical connection detailed in the instruction manual of the electrical appliance used.

Further installation instructions

- ◆ In order to ensure optimal operation, the DuoFern Universal Actuator 9470-1 should not be installed on a metallic base or near metal objects.
- ◆ The DuoFern Universal Actuator 9470-1 is intended for flush mounting. We recommend installation in a deep 58 mm flush-mounted box or in an electronic socket.

1. Ensure the mains is disconnected and check whether the mains power leads are current-free.
2. Securely lay the connecting cables right into the flush-mounted box of the DuoFern Universal Actuator 9470-1.
3. Remove the insulation on all leads as specified above and connect them according to the following connection diagram.
4. Insert the DuoFern Universal Actuator 9470-1 into the flush-mounted box and lay the connecting cables as well as the antenna in the box.
5. Finally, install the cover of the flush-mounted box and switch on the electricity again.

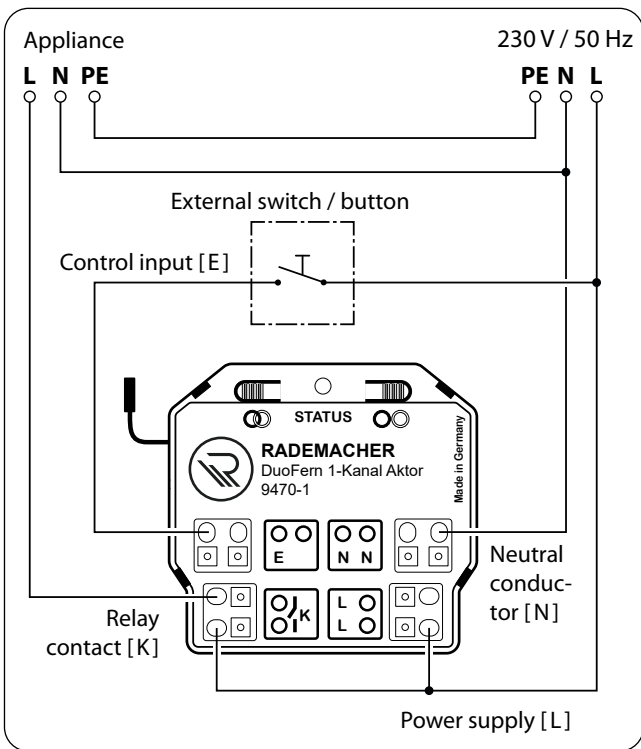

Required connecting cable and cable cross-section for connecting the electrical appliance:

Ø 1,5 mm²

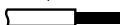

Only use a solid copper cable with a cross-section of 1.5 mm².

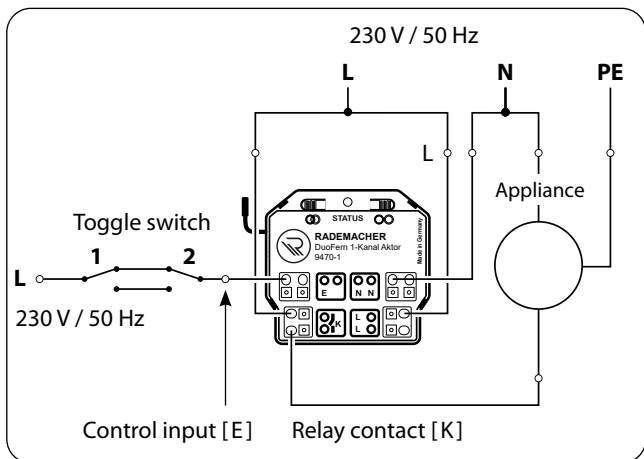



Installation with toggle switches

We recommend replacing the toggle switch with several switches connected in parallel.

You can find further circuit examples on our website at:

www.rademacher.de

For the DuoFern Universal Actuator 9470-1 to be operated with a DuoFern transmitter, you must log each desired transmitter onto the DuoFern Universal Actuator 9470-1. You can log on a maximum of 20 DuoFern transmitters (e.g. DuoFern manual transmitter standard).

1. Switch the desired DuoFern transmitter to log-on/log-off mode (please refer to the respective instruction manual).
2. Press the "Connect (log-on) button" [] or the "Disconnect (log-off) button" [] of the DuoFern Universal Actuator 9470-1.
3. The DuoFern Universal Actuator 9470-1 then transmits either a log-on or log-off signal.
Log-on / log-off mode remains active for 120 seconds.
4. If the log-on/log-off process is successful, the STATUS LED will light up green constantly.
5. Log on / log off from the next DuoFern transmitter. To do so, repeat steps 1 to 3 or else terminate the log-on / log-off process.

Observe the STATUS LED

The status LED lights up red if the log-on / log-off process fails, for example if:

- ◆ 20 DuoFern transmitters have already been logged on.
- ◆ An unsuitable device (e.g. other DuoFern Actuator) is logged on.
- ◆ An attempt was made to log off from a DuoFern transmitter that is not logged on.

You can control the DuoFern Universal Actuator 9470-1 directly using the radio code in order, for example, to be able to connect further DuoFern transmitters to the actuator after installation. You will find the radio code on the enclosed label and on the rear side of the DuoFern Universal Actuator 9470-1.



Please note that the use of the radio code is limited to 120 minutes after switching on the power supply



A detailed description on activating the radio code function can be found in the instruction manual of the DuoFern Manual Control and the SmartHome Box.

A reset can be carried out to reset the DuoFern Universal Actuator 9470-1 to the default factory settings.

1.  Press and hold the disconnect button for approx. 5 sec. until the STATUS LED constantly lights up red.
2. All of the settings are deleted and reset to the default factory settings and the logged-on DuoFern transmitters are automatically logged off.
3. The DuoFern Universal Actuator 9470-1 is then reset to the default factory settings.



There is a risk of fatal electric shock when touching electrical components.

- ◆ Disconnect all phases of the mains power lead and secure it to prevent any reconnection. Check that the system is de-energised.
1. Log the DuoFern controller off from the DuoFern network.
 2. Ensure the mains power is current-free and open the flush-mounted box.
 3. Disconnect the DuoFern Universal Actuator 9470-1 and completely remove it from the flush-mounted box.



DELTA DORE RADEMACHER GmbH hereby declares that the DuoFern Universal Actuator 9470-1 complies with the Directive **2014/53/EU (Radio Equipment Directive)**.

The full text of the declaration of conformity is available at the following website:

www.rademacher.de/ce

Warranty terms and conditions

Information on our warranty conditions is enclosed separately with this product.

DELTA DORE RADEMACHER GmbH
Buschkamp 7
46414 Rhede - GERMANY

Subject to technical modifications, misprints and errors excepted. Illustrations not binding.