

EN**DuoFern Wall Controller 1-channel 9494-3**

Translation of the Original installation and commissioning instruction manual

Item no. 3250 19 73 / Type: 9494 -3 (surface-mounted with battery)

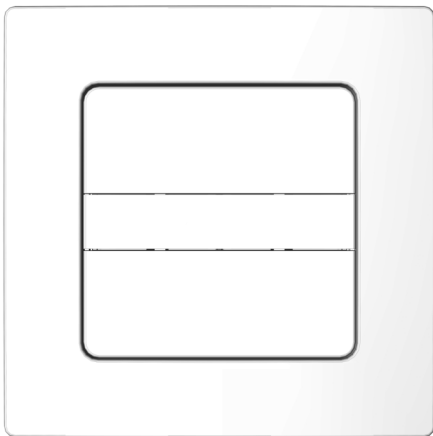

1. This manual...	4
1.1 How to use this manual	4
2. Hazard symbols	5
2.1 Levels of danger and signal words	5
2.2 Symbols and depictions used	6
3. Safety instructions	7
3.1 Intended use	7
3.2 Improper use	8
3.3 Expert knowledge required by the installer	8
3.4 Glossary - definition	8
4. Included in delivery	9
5. Front view of the operating unit	11
6. Product description	12
6.1 Button functions	13
6.2 Button combinations	14
7. Technical specifications	15
8. Installation	16
8.1 Selecting a suitable installation location	16
8.2 Installing the DuoFern Wall Controller	17
9. Commissioning	19
9.1 Logging on DuoFern Devices	20
9.2 Logging off DuoFern devices	22
9.3 Clearing the DuoFern network	23
10. Activating the jog mode	24
10.1 Operation in jog mode	25
11. Changing the rotation direction / mode	26

12. Changing the battery	28
13. Deleting all settings, software reset.....	30
14. Dismantling.....	30
15. Simplified EU declaration of conformity.....	31

...describes the installation, commissioning and operation of your DuoFern Wall Controller 1-channel* 9494-3.

** Hereinafter referred to as "DuoFern Wall Controller"*

1.1 How to use this manual

- ◆ Before you begin, please read this manual through completely and follow all the safety instructions.
- ◆ Please also read the instruction manuals of the logged on DuoFern devices as well as of the respective connected appliance.
- ◆ This manual is part of the product. Please store it in an easily accessible place.
- ◆ When passing the DuoFern Wall Controller on to a third party, this manual must be passed on as well.
- ◆ Damage resulting from non-compliance with these instructions and safety instructions will void the warranty. We assume no liability for any consequential damage.



2. Hazard symbols

The following hazard symbols are used in this manual:



Danger of fatal electric shock



Danger area / dangerous situation



2.1 Levels of danger and signal words

 **DANGER!**

This hazard will lead to serious injury or death if not avoided.

 **WARNING!**



This hazard may result in serious injury or death if not avoided.

 **CAUTION!**

This hazard may result in minor or moderate injury if not avoided.

 **ATTENTION!**

This hazard may lead to property damage.

Depiction	Description
1.	Procedures
2.	
◆	Itemisation
1) or a)	Lists
	Further useful information
	Please read the respective manual.



The use of defective equipment can lead to personal injury and damage to property.

- ◆ Never use defective or damaged devices.
- ◆ Check the DuoFern Wall Controller for damage.
- ◆ Consult our customer service department in the event that you discover damage.

3.1 Intended use

Only use the DuoFern Wall Controller to log on and control DuoFern devices.

Operating conditions

- ◆ The associated tubular motor must be fitted with a mechanical or electronic end position switch.
- ◆ Only use the DuoFern wall controller in dry rooms.
- ◆ The installation and operation of the radio systems is only permitted for those systems and devices where a malfunction in the transmitter or receiver would not cause a danger to personnel or property or where this risk is already covered by other safety equipment.

Using the DuoFern Wall Controller for any other purpose than previously mentioned is not permissible.



Improper use can lead to serious injuries or property damage.

Never use the radio system (e.g. DuoFern radio system) and its components for the remote control of appliances and systems with increased safety-relevant requirements or where there is an accident risk. Applications of this kind require additional safety equipment. Observe the respective statutory regulations for the installation of such systems.

3.3 Expert knowledge required by the installer

The installation and commissioning of the DuoFern Wall Controller must only be carried out in accordance with the instructions in this manual.

3.4 Glossary - definition

DuoFern

- ◆ RADEMACHER radio technology for controlling compatible products.

SmartHome Box

- ◆ The SmartHome Box is a central controller unit for RADEMACHER radio products.



4. Included in delivery

EN

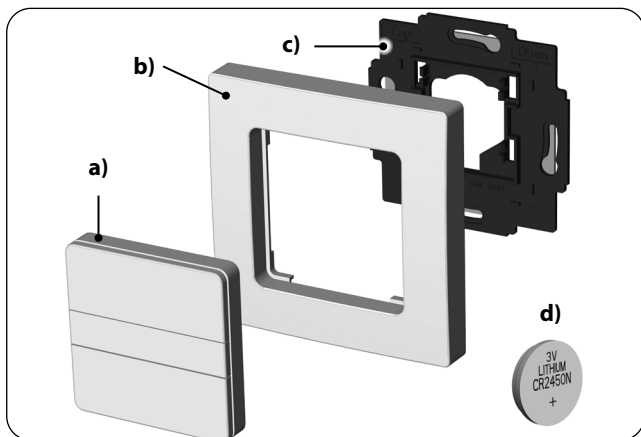

- a)** 1 x Operating unit (50 x 50 mm)
- b)** 1 x Frame
- c)** 1 x Wall bracket
- d)** 1 x Battery (type: CR2450 / Li-Mn)

Not shown

- e)** 1 x black central bar (optionally exchangeable)
- f)** 1 x double-sided adhesive strip
- g)** 1 x instruction manual

After unpacking please check and compare...

... the contents of the package with those specified above.



4. Included in delivery

EN

Changing the central bar if required

If required you can also replace the white central bar pre-installed at the factory with the black one supplied.

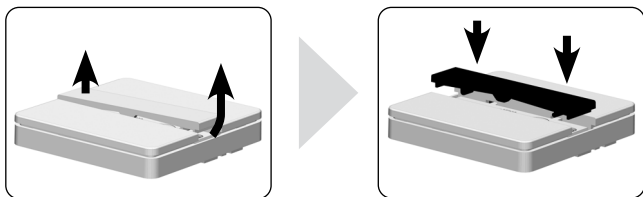

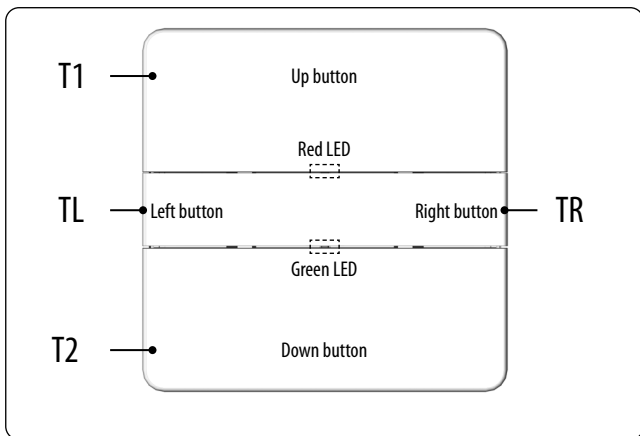

Symbol	Description
T1	Operating button 1
T2	Operating button 2
TL	Left set button
TR	Right set button
Red LED	Status LEDs
Green LED	

* The buttons are not labelled at the factory, the labelling in the illustration provides a better understanding.

Function

The DuoFern Wall Controller serves to log on and control various DuoFern devices. You can transfer the desired control commands to the logged on DuoFern devices with the two operating buttons **T1** and **T2**. Two LEDs (red/green) provide information on the respective status of the operation.

Max. number of DuoFern devices

A maximum of 16 DuoFern devices can be logged on. When logging on, the individual DuoFern devices are automatically detected and recognised by the DuoFern Wall Controller.

Jog mode

To control Venetian blinds with slats, the DuoFern Wall Controller can be switched to jog mode.



6.1 Button functions

EN

Controller	Design	Function		
	Activate or deactivate the light or appliance	1 x tap	ON	OFF
	Control roller shutters / Venetian blinds	1 x tap	UP	DOWN
		Tap again	STOP	STOP
	Roller shutters / Venetian blinds in jog mode	1 x tap	Briefly UP	Briefly DOWN
		1 x long	UP	DOWN
		Tap again	STOP	STOP
 100 % 0 %	Dim light or save intermediate values	1 x tap	0 to 100 %	100 % to 0
		2 x tap	Go directly to 100 %	Go directly to 0
		1 x tap in opposite direction	e.g. save 75 %	e.g. save 45 %
		Press and hold	0 to 100 %	100 % to 0
		Release	e.g. save 75 %	e.g. save 45 %

Recommendation for pressing the buttons simultaneously

In order to avoid inadvertently switching off logged on devices, you should first press the middle button (right/left) and then press the respective operating button and hold both.

Activate the registering mode, see page 20.

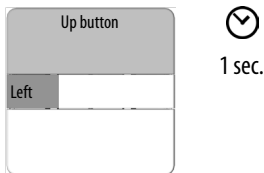

Activate the log-off mode, see page 22.

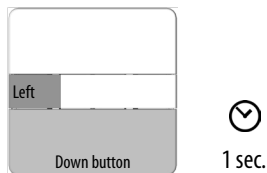

Clear the DuoFern network, see page 23.

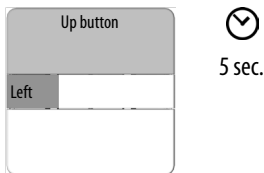

Activate the jog mode, see page 24.

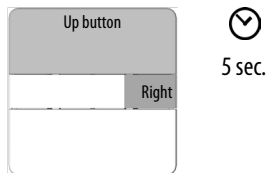

Change rotation direction/ mode, see page 26.

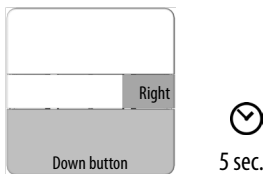

Software reset, see page 30.

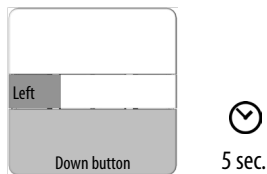

General information	
Nominal voltage:	3 V (DC)
Battery type:	1 x CR2450
Battery life:	2 years, with four switching processes per day. * * Depending on the number of logged on DuoFern devices
Permissible ambient temperature:	0 to 40°C
Protection class:	II (only for use in dry rooms)
Dimensions (W x H x D):	50 x 50 x 12 mm (operating unit)
DuoFern radio technology	
Transmission frequency:	434.5 MHz
Transmission power:	max. 10 mW
Range:	indoors: approx. 30 m * outdoors: approx. 100 m * Depending on the building structure
Maximum number of DuoFern devices:	16
Factory settings	
DuoFern devices:	none
Jog mode:	deactivated



8.1 Selecting a suitable installation location

Avoid installation near disturbing sources



Radio systems that transmit on the same frequency can cause interference.

- ◆ Do not install the DuoFern Wall Controller in the proximity of powerful radio systems.
- ◆ In order to ensure optimal operation, the DuoFern Wall Controller should not be installed on a metallic base or near metal objects.

The DuoFern Wall Controller 9494-3 is intended for surface mounting. The supplied wall bracket can be screwed in place or stuck to the wall.

1. Select and mark the desired installation position.
2. Pull the protective film from the adhesive strip provided and stick it on the back of the wall bracket.
3. Remove the second protective film and firmly press the wall bracket with the adhesive strip on to the wall.



The labelling TOP/OBEN must point upwards.

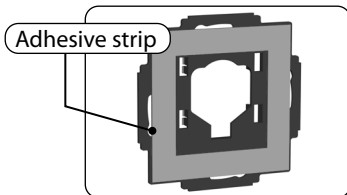

If you wish to screw the wall bracket on, you will need to drill the according installation holes and use appropriate wall plugs and screws.

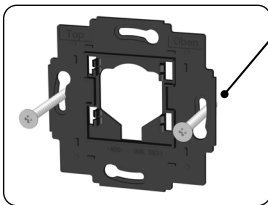

* Screws not included in the scope of delivery.

4. Carefully pull the separating film from the battery compartment.



5. Finally, press the operating unit and the frame on to the wall bracket so that the frame lies flush with the wall.

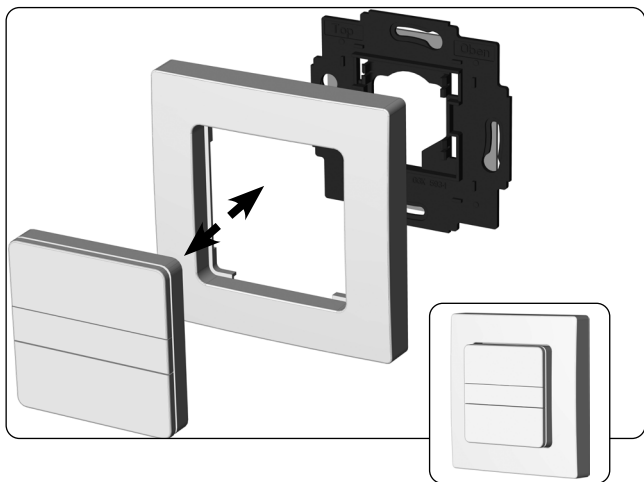

Information for logging on DuoFern devices



Only the same DuoFern devices or device classes can be logged on to the wall controller.

When logging on, the individual DuoFern devices are automatically detected and recognised by the DuoFern Wall Controller.



Please read the instruction manual for the respective DuoFern device.

Max. number of DuoFern devices

A maximum of 16 DuoFern devices can be logged on.

Observe the red LED

The red LED flashes quickly if the log-on was unsuccessful. For example, if...

- ◆ the maximum number of 16 DuoFern devices is reached.
- ◆ an unsuitable device is logged on.

1. Switch the desired DuoFern device to the registering mode (please refer to the relevant instruction manual).

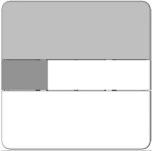
2.  1 sec. Activate the registering mode on the DuoFern Wall Controller.
Simultaneously press and hold buttons **TL + T1** for 1 second.
The green LED flashes.

-  120 sec. The registering mode remains active for approx. 120 seconds.

3. If you have logged on successfully, the green LED lights up for approx. 2 seconds.
4. Log on the next DuoFern device.

Logging on multi-channel actuators:

1. Switch the desired DuoFern device to the registering mode (please refer to the relevant instruction manual).
 2. Activate the registering mode on the wall controller, as described above.
-

Both LEDs light up continuously if a multi-channel actuator is detected.

 120 sec.

The registering mode remains active for approx. 120 seconds.

3. Accepting the first channel (log on):

Tap on any random button briefly (< 5 seconds).

If the accept command is successful, the **green LED** flashes three times.

or

Skipping the first channel:



Press and hold any random button for 5 seconds.

If the skip command is successful, the **red LED** flashes three times.

If the command to accept or skip a channel is successful, both LEDs light up again continuously.

4. Accept or skip the second channel.
Proceed as described in point 3.
 5. Log on the next DuoFern device.
-

1. Switch the desired DuoFern device to the log-off mode (please refer to the relevant instruction manual).

2.  1 sec. Activate the log-off mode on the DuoFern Wall Controller.
Simultaneously press and hold buttons **TL + T2** for 1 second.
The red LED flashes.
 120 sec. The log-off mode remains active for approx. 120 seconds.

3. If you have logged off successfully, the green LED lights up for approx. 2 seconds.

This function enables you to log off all DuoFern devices from the DuoFern Wall Controller that are no longer accessible via radio.



Not all battery-operated DuoFern devices can be logged off in this way.

A software reset must be carried out in order to log off and delete all DuoFern devices, see page 30.

1.  5 sec. Activate the clearing function.

Simultaneously press and hold buttons **TL + T1** for 5 seconds.

During the clearing function:

- ◆ The green LED flashes first,
- ◆ then the green LED lights up continuously and the red LED flashes until the clearing function is completed.

2. If the clearing function has been successfully completed, the green LED then lights up for approx. 2 seconds.

Cancelling the clearing function

You can cancel the clearing function at any time by briefly pressing any random button.

In the jog mode, the DuoFern Wall Controller can be used, for example, to control Venetian blinds.

Displaying the jog mode status

1.

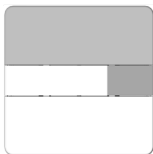

Simultaneously press and hold buttons **TR + T1** briefly and release.

Then observe the LEDs:

If the green LED lights up, the jog mode is activated

If the red LED lights up, the jog mode is deactivated

Activating / deactivating the jog mode

2.



5 sec. Simultaneously press and hold buttons **TR + T1** for 5 seconds.

The LED will change from green to red or vice versa depending on the status.

Tilting the slats

Tapping the operating buttons briefly enables Venetian blind slats to be conveniently configured.

Driving the slats into the end position

Press the operating button longer to drive the Venetian blinds into the end point. The run can be stopped briefly by tapping the button again briefly, see page 13 - "Button functions".

This function can be used to change the rotation direction of a logged on radio tubular motor or the mode of a DuoFern Switch Actuator.



To use this function, only one component may be logged on to the wall controller.

Log on the desired DuoFern component to change the rotation direction or mode. If several devices are already logged on, these must first be logged off, for example, by carrying out a software reset on the wall controller.

Checking whether the rotation direction / mode can be changed

1.



Simultaneously press and hold buttons **TR + T2** briefly and release.

Then observe the LEDs:

If the green LED flashes,
they can be changed

If the red LED flashes,
they cannot be changed

Changing the rotation direction / mode

2.



5 sec. Simultaneously press and hold buttons **TR + T2** for 5 seconds.

The red LED lights up initially. Then the green LED lights up for 2 seconds if the rotation direction / mode has been changed.

The red LED lights up for 2 seconds if the change of rotation direction or mode has failed.



This product contains a coin / button cell battery. If the coin/ button cell battery is swallowed, it can cause severe internal burns in just 2 hours and can lead to death.

- ◆ Replacement of batteries shall not be done by children.
- ◆ Do not ingest battery ,Chemical Burn Hazard.
- ◆ Keep new and used batteries away from children. If the battery compartment does not close securely, stop using the product and keep it away from children. If you think batteries might have been swallowed or placed inside any part of the body, seek immediate medical attention.



Risk of fire or explosion

- ◆ Replacement of a battery with an incorrect type that can defeat a safeguard Or Risk of fire or explosion if the battery is replaced by an incorrect type
- ◆ Disposal of a battery into fire or a hot oven, or mechanically crushing or cutting of a battery, that can result in an explosion;
- ◆ Leaving a battery in an extremely high temperature surrounding environment that can result in an explosion or the leakage of flammable liquid or gas;
- ◆ A battery subjected to extremely low air pressure that may result in an explosion or the leakage of flammable liquid or gas.

If the battery has discharged, the red LED flashes three times when any random button is pressed for a short time. The battery must be replaced.

1. Carefully pull the operating unit out of the wall bracket.
2. Carefully press the battery out of the battery compartment using a flat, non-conductive object (e.g. a plastic rod).
3. Replace the battery with a battery of the same type "CR2450". Observe the correct polarity when inserting a new battery.
4. Then insert the operating unit into the wall bracket again .

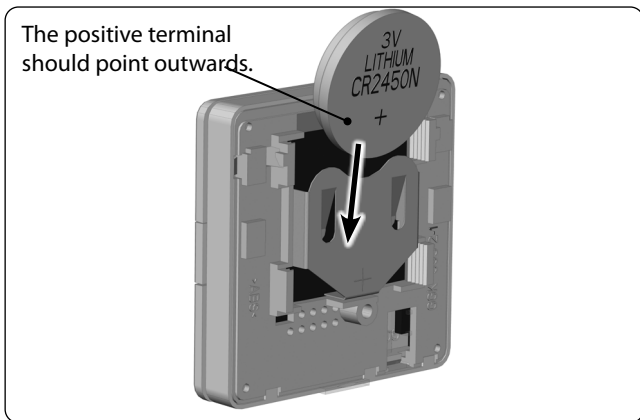

A software reset must be carried out to reset the DuoFern Wall Controller to the original factory settings.

1.



Simultaneously press buttons **TL + T2** until the red LED lights up red continuously after initially flashing.

-
2. All settings have been deleted and reset to the original factory settings. All logged on DuoFern devices have been automatically logged off.

14. Dismantling

-
1. Carry out a software reset to log off all DuoFern devices from the DuoFern Wall Controller.
-
2. Carefully pull the operating unit and then the frame out of the wall bracket.
-
3. Remove the wall bracket from the wall.
-
4. If required, remove the battery from the DuoFern Wall Controller.



DELTA DORE RADEMACHER GmbH hereby declares that the DuoFern Wall Controller 9494-3 complies with the Directive **2014/53/EU (Radio Equipment Directive)**.

The full text of the declaration of conformity is available at the following website:

www.rademacher.de/ce

Warranty terms and conditions

Information on our warranty conditions is enclosed separately with this product.

Disposal



This marking indicates that this product should not be disposed with other household wastes throughout the EU. To prevent possible harm to the environment or human health from uncontrolled waste disposal, recycle it responsibly to promote the sustainable reuse of material resources. To return your used device, please use the return and collection systems or contact the retailer where the product was purchased. They can take this product for environmental safe recycling.

DELTA DORE RADEMACHER GmbH
Buschkamp 7
46414 Rhede - GERMANY

Subject to technical modifications, misprints and errors excepted. Illustrations not binding.