

**EN DuoFern Multiple Wall Controller 9494-1**  
Instruction manual for the electrical connection and for commissioning

Item no. 3250 19 74 / Type: 9494 -1 (surface-mounted with battery)

---

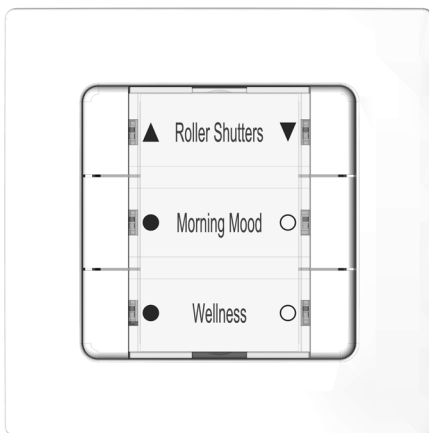

<b>1. This manual...</b>	<b>4</b>
1.1 How to use this manual	4
<b>2. Hazard symbols</b>	<b>5</b>
2.1 Levels of danger and signal words	5
2.2 Symbols and depictions used	6
2.3 Glossary - definition	6
<b>3. Included in delivery</b>	<b>7</b>
<b>4. Front view of the operating unit</b>	<b>8</b>
<b>5. Product description</b>	<b>9</b>
5.1 Button functions	10
5.2 Button combinations	11
<b>6. Technical specifications</b>	<b>12</b>
<b>7. Safety instructions</b>	<b>13</b>
7.1 Intended use	13
7.2 Improper use	14
7.3 Required expert knowledge of the installer	14
<b>8. Installation</b>	<b>15</b>
8.1 Printing the label insert	15
8.2 Selecting the suitable installation location	16
8.3 Installation of the DuoFern Multiple Wall Controller	17
<b>9. Commissioning</b>	<b>19</b>
9.1 Logging on DuoFern Devices	20
9.2 Logging off DuoFern devices	22
9.3 Logging on to the SmartHome Box	23
9.4 Clearing up the DuoFern network	25
<b>10. Activating the jog mode</b>	<b>26</b>
10.1 Operation in jog mode	27
<b>11. Changing the direction of rotation</b>	<b>28</b>
<b>12. Changing the battery</b>	<b>29</b>

---

13. Erase all settings, software reset .....	30
14. Dismantling .....	30
15. Simplified EU Declaration of Conformity.....	31
16. Cut out label insert.....	33



## 1. This manual...

...describes the installation, commissioning and operation of your DuoFern Multiple Wall Controller 9494-1.



### 1.1 How to use this manual

- ◆ Before you begin, please read this manual through completely and follow all the safety instructions.
- ◆ Please also read the instruction manuals of the logged on DuoFern devices as well as of the respective connected appliance.
- ◆ This manual is part of the product. Please store it in an easily accessible place.
- ◆ When passing the DuoFern Multiple Wall Controller on to a third party, this manual must be passed on as well.
- ◆ Damage resulting from non-compliance with these instructions and safety instructions will void the warranty. We assume no liability for any consequential damage.



## 2. Hazard symbols

EN

The following hazard symbols are used in this instruction manual:



**Danger of fatal electric shock**



**Danger area / dangerous situation**



### 2.1 Levels of danger and signal words

 **DANGER!**

This hazard will lead to serious injury or death if not avoided.

 **WARNING!**



This hazard may result in serious injury or death if not avoided.

 **CAUTION!**

This hazard may result in minor or moderate injury if not avoided.

 **ATTENTION!**

This hazard may lead to property damage.

Depiction	Description
1.	Procedures
2.	
◆	Itemisation
1) or a)	Lists
	further useful information
	Please read the respective manual.

**DuoFern**

- ◆ RADEMACHER radio technology for controlling compatible products.

**SmartHome Box**

- ◆ The SmartHome Box is a central controller unit for RADEMACHER radio products.

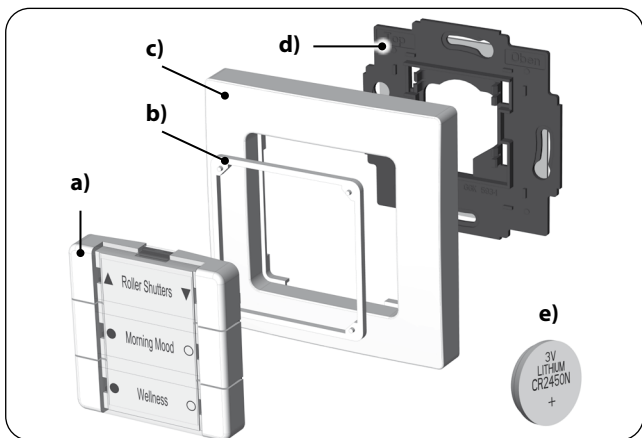

- a) 1 x Operating unit (50 x 50 mm) with removable cover panel for the label insert
- b) 1 x Spacer frame
- c) 1 x Frame
- d) 1 x Wall bracket
- e) 1 x Battery (type: CR2450 / Li-Mn)

**Not illustrated**

- f) 1 x double-sided adhesive strip
- g) 1 x Label insert, see page 15.
- h) 1 x Instruction manual

**After unpacking please check and compare...**

... the contents of the package with those specified above.



## 4. Front view of the operating unit

EN

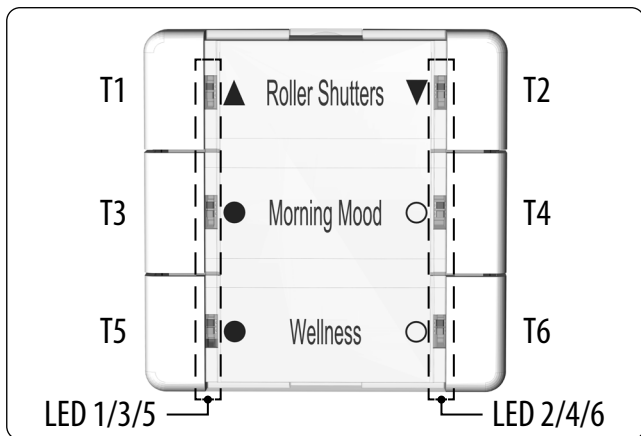

Symbol	Description
T1 to T6	Buttons 1 to 6
LED 1 to LED 6	Each button has a red/green LED



### Function

---

The DuoFern Multiple Wall Controller serves to log on and control various DuoFern devices. The six operating buttons can be used to transmit the desired commands to the logged on DuoFern devices. Six two-tone LEDs (red/green) provide information on the respective status of the operation.

### Max. number of DuoFern devices

---

A maximum of 8 DuoFern devices can be logged on per button group. When logging on, the individual DuoFern devices are automatically detected and recognised by the DuoFern Multiple Wall Controller.

### Jog mode







---

To control Venetian blinds with slats, the DuoFern Multiple Wall Controller can be switched to jog mode.

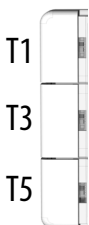

## 5.1 Button functions

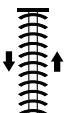
**EN**

Controller	Design	Function		
		 T1 T3 T5	 T2 T4 T6	
	<b>Activate or deactivate the light or appliance</b>	1 x tap	ON	OFF
	<b>Control roller shutters / Venetian blinds</b>	1 x tap	UP	DOWN
		tap again	STOP	STOP
	<b>Roller shutters / Venetian blinds in jog mode</b>	1 x tap	briefly UP	briefly DOWN
		1 x long	UP	DOWN
		tap again	STOP	STOP
 100 % 0 %	<b>Dim light or save interim values</b>	1 x tap	0 to 100 %	100 % to 0
		2 x tap	go directly to 100 %	go directly to 0
		1 x tap in opposite direction	e.g. save 75 %	e.g. save 45 %
		Press and hold	0 to 100 %	100 % to 0
		release	e.g. save 75 %	e.g. save 45 %

Activate the log-on mode,  
see page 20.



Activate the log-off mode,  
see page 22.



Clear the DuoFern  
network, see page 25.



Activate the jog mode,  
see page 26.



Activate the reversal of  
rotation direction mode,  
see page 28.



Software reset,  
see page 30.



General information	
Nominal voltage:	3 V (DC)
Battery type:	1 x CR2450
Battery life:	2 years, with four switching processes per day.* * Depending on the number of DuoFern devices logged on.
Permissible ambient temperature:	0 to 40 °C
Protection class:	II (only for use in dry rooms)
Dimensions (W x H x D):	50 x 50 x 12 mm (operating unit)
DuoFern radio technology	
Transmission frequency:	434.5 MHz
Transmission power:	max. 10 mW
Range:	indoors: approx. 30 m* outdoors: approx. 100 m * depending on the building structure
Max. number of DuoFern devices:	8 per button group 24 in total
Factory settings	
DuoFern devices:	none
Jog mode:	deactivated, for all groups



**The use of defective equipment can lead to personal injury and damage to property.**

- ◆ Never use defective or damaged equipment.
- ◆ Check that the DuoFern Multiple Wall Controller is intact.
- ◆ Consult our customer service department in the event that you discover damage, see page 34.



**Danger to life from acid burns**

- ◆ Keep children away from new and used batteries. If a battery has been swallowed, medical assistance must be requested immediately.
- ◆ In case of contact with the skin, eyes or mucous membranes, there is a risk of burns from the battery acid,
- ◆ Take leaking batteries out of the device immediately, see page 29.

### 7.1 Intended use

Only use the DuoFern Multiple Wall Controller to log on and control DuoFern devices.

#### Operating conditions

- ◆ The associated tubular motor must be fitted with a mechanical or electronic end position switch.
- ◆ Only use the DuoFern Wall Controller in dry rooms.

## **i** 7.1 Intended use

---

- ◆ The installation and operation of the radio systems is only permitted for those systems and devices where a malfunction in the transmitter or receiver would not cause a danger to personnel or property or where this risk is already covered by other safety equipment.

## **i** 7.2 Improper use

---

Using the DuoFern Multiple Wall Controller for any other purpose than previously mentioned is not permissible.

---



**Improper use can lead to serious injuries or property damage.**

---

Never use the radio system (e.g. DuoFern radio system) and its components for the remote control of appliances and systems with increased safety-relevant requirements or where there is an accident risk. Such applications require additional safety equipment. Observe the respective statutory regulations for the installation of such systems.

## **i** 7.3 Required expert knowledge of the installer

---

The installation and commissioning of the DuoFern Multiple Wall Controller must only be carried out in accordance with the instructions in this manual.



## 8. Installation

EN



### 8.1 Printing the label insert

1. The provided label insert can be printed with the application specified by you. Please only use a laser printer for printing. \*
2. Lift the transparent cover panel from the operating panel and insert the printed paper into the cover panel. Next, press the cover panel on to the operating unit until it locks in place.

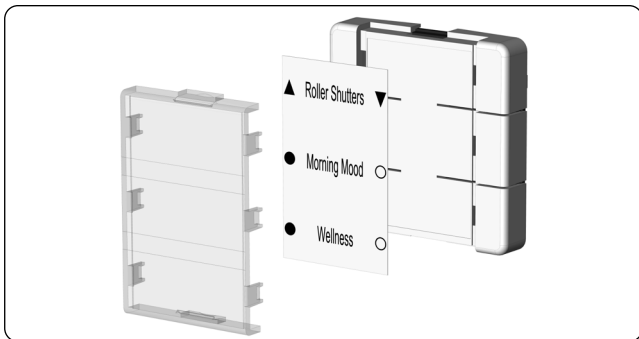

Templates can be found on our website: [here](http://www.rademacher.de), individual label inserts can be created and printed.

\* Should you have no access to a laser printer, please alternatively use standard printing paper for the label insert.

**Avoid installation near disturbing sources**

Radio systems that transmit on the same frequency can cause interference.

- ◆ Do not install the DuoFern Multiple Wall Controller in the proximity of powerful radio systems.
- ◆ In order to ensure optimal operation, the DuoFern Multiple Wall Controller should not be installed on a metallic base or near metal objects.



Do not install the device above a height of 2 m.



The DuoFern Multiple Wall Controller 9494-1 is intended for surface-mounting. The supplied wall bracket can be screwed in place or stuck to the wall.

1. Select and mark the desired installation position.
2. Pull the protective film from the adhesive strip provided and stick it on the back of the wall bracket.
3. Remove the second protective film and firmly press the wall bracket with the adhesive strip on to the wall.

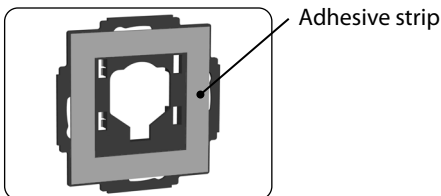

If you wish to screw the wall bracket on, you will need to drill the according installation holes and use appropriate wall plugs and screws.

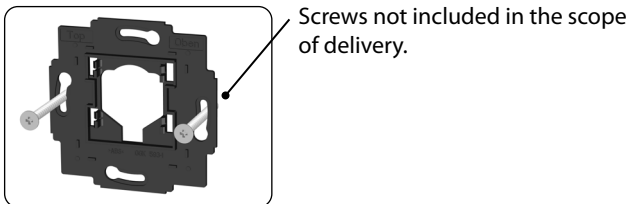



## 8.3 Installation of the DuoFern Multiple Wall Controller

EN

4. Carefully pull the separating film from the battery compartment.



5. Press the space frame onto the operating unit from the back.
6. Finally, press the operating unit and the frame on to the wall bracket so that the frame lies flush with the wall.

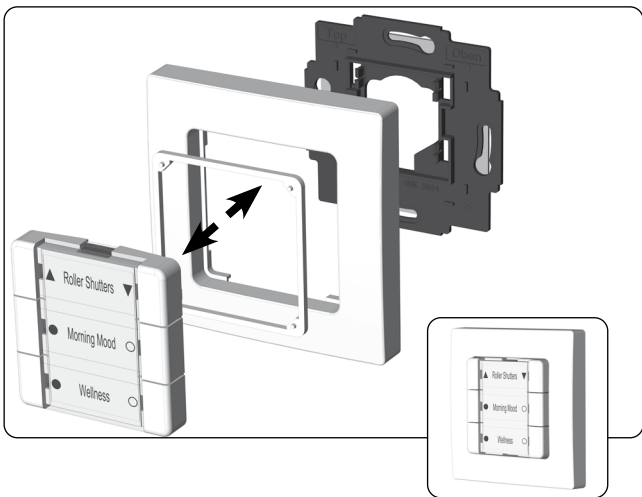

### Information for logging on DuoFern devices

---



Only DuoFern devices or devices within the same class/category can be allocated to a specific button group.

When logging on, the individual DuoFern devices are automatically detected by the DuoFern Multiple Wall Controller, and the available button groups are displayed.



Please read the instruction manual for the respective DuoFern device.

### Max. number of DuoFern devices

---

You can log a maximum of 8 DuoFern devices on to each button group.

1. Switch the desired DuoFern device to the registering mode (please refer to the relevant instruction manual).

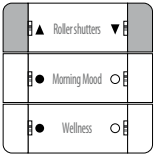
2.  1 sec. Activate the registering mode of the DuoFern Multiple Wall Controller. Simultaneously press and hold the buttons 1 and 2 for 1 second. LEDs 1 and 2 will flash green.

120 sec.

The registering mode remains active for approx. 120 seconds.

3. After successfully logging on, the LEDs of the remaining available buttons will light up green.

4. Tap on the desired available button group to allocate the new DuoFern device to this button group. You can use the left or right button.

The successful assignment is confirmed by the green LEDs flashing three times briefly.

#### Notes on multi-channel actuators

The first channel is initially assigned with multi-channel actuators and then confirmed by the green LEDs flashing three times briefly. The LEDs that are still free then light up green again.

The next channel can now be assigned by tapping the desired free button group.

**If you want to skip a channel when logging on, proceed as follows as soon as the free LEDs light up green:**

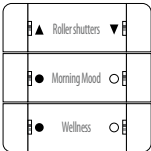
5.  5 sec. Press any button and hold for 5 seconds.

6. Once the channel has been successfully skipped, all LEDs will briefly flash red.
7. You can then assign the next channel if the actuator has more channels available.
8. Log-on the next DuoFern device.

### Pay attention to the LEDs

All LEDs will light up red, one after the other, if the log-on was unsuccessful. For example, if...

- ◆ 8 DuoFern devices are already logged on to a button group.
- ◆ an unsuitable device is logged on.

1. Switch the desired DuoFern device to the log-off mode (please refer to the relevant instruction manual).

2.

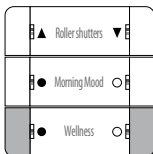

Activate the log-off mode on the DuoFern Multiple Wall Controller. Simultaneously press and hold the buttons 5 and 6 for 1 second.

LEDs 5 and 6 will flash red.

The log-off mode remains active for approx. 120 seconds.

1 sec.

⌚ 120 sec.

3. After successfully logging off, the LED of the relevant button will light up green.

In combination with the SmartHome Box, all 6 buttons of the DuoFern Multiple Wall Controller can be used to individually trigger scenes. To do so, it must first be logged on to the SmartHome Box.

1. Open the user interface of the SmartHome Box and click left on the button [**configuration**] and then on [**register devices**].

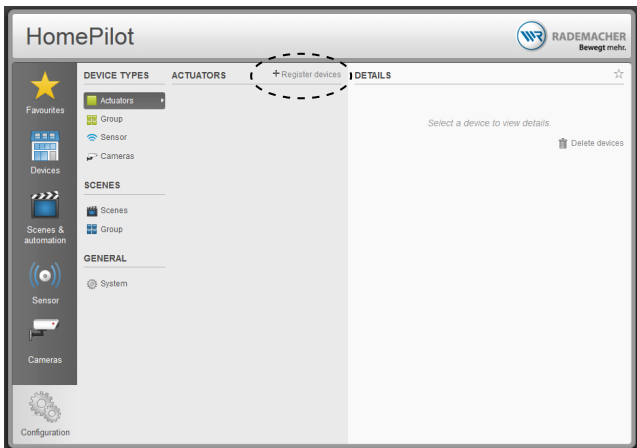

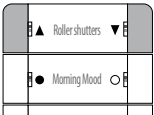
2.  1 sec. Simultaneously press and hold the buttons 1 and 2 for 1 second to activate the registering mode of the DuoFern Multiple Wall Controller.

3. Once successfully logged on, the DuoFern Multiple Wall Controller will be displayed in the left table:

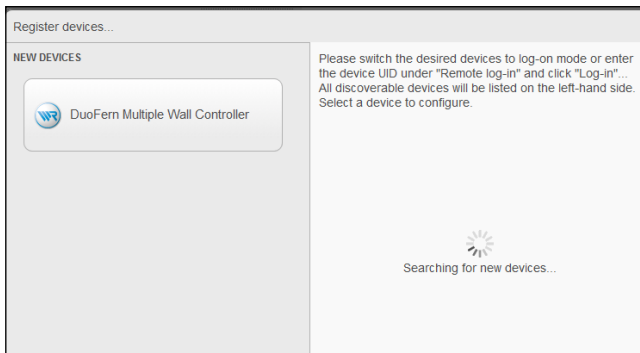

4. Click on the device and assign an individual name, if required. In addition, a graphic symbol can be selected.
5. Save the setting.



This function enables you to log off all DuoFern devices from the DuoFern Multiple Wall Controller that are no longer accessible via radio.



Not all battery-operated DuoFern devices can be logged off in this way.

A software reset must be carried out in order to logout and delete all DuoFern devices, see page 30.

1.

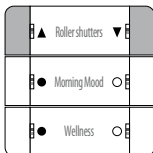

5 sec. Activate the clear up.

Simultaneously press and hold the buttons 1 and 2 for 5 seconds.

During the clear up period, LEDs 1 + 2 will flash red.

2. Once the clear up process has been successfully completed, LEDs 1 + 2 will briefly light up green.

### Cancelling the clear up function

You can cancel the clearing process at any time by briefly pressing any random button.

In the jog mode, the DuoFern Multiple Wall Controller can be used, e.g. to control Venetian blinds.

 5 sec.

Attention! The switching mode only remains active for approx. 5 seconds.

### Activate the jog mode for one button group

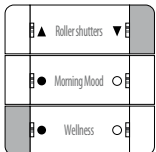
- 

1 sec. Activate the switching mode.  
Simultaneously press and hold the buttons 2 and 5 for 1 second.  
LEDs 2 and 5 will flash red.

- If there is a switching mode for one of the button groups, the according LEDs 1 to 6 will light up green.

left LED green

jog mode is deactivated

right LED green

jog mode is activated

### **Tilting the slats**

---

Briefly tapping the operating buttons enables Venetian blinds slats to be conveniently configured.

### **Driving the slats into the end position**

---

Press the operating button longer to drive the Venetian blinds into the end position. The drive can be stopped by briefly tapping the button again, see page 10 "Button functions".

This function can be used to change the direction of rotation of a connected DuoFern component (e.g. a radio tubular motor) as required.



To use this function, only one component may be logged on per button group.

If several devices are already logged on, log on the DuoFern component for which you want to change the direction of rotation to one of the free button groups.

-  5 sec. Attention! The reversal of rotation direction mode only remains active for approx. 5 seconds.

### Activating the reversal of rotation direction mode

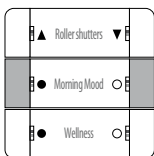
1.  1 sec. Simultaneously press and hold buttons 3 and 4. LEDs 3 and 4 will flash red.

2. If there is a reversal of rotation direction mode for one of the button groups, the associated LEDs 2, 4 and 6 will light up green.
3. Press any button in the indicated button group to reverse the rotation direction.
4. LEDs 1, 3 and 5 will briefly light up red and turn green once the direction of rotation has successfully been reversed.

If the battery has discharged and needs to be changed, all red LEDs will briefly light up when any random button is pressed.

1. Carefully pull the operating unit out of the wall bracket.
2. Carefully press the battery out of the battery compartment using a flat, non-conductive object (e.g. a plastic rod).
3. Replace the battery with a battery of the same type "CR2450". Pay attention to the correct polarity when inserting a new battery.
4. Then insert the operating unit into the wall bracket again .

The positive terminal should point outwards.

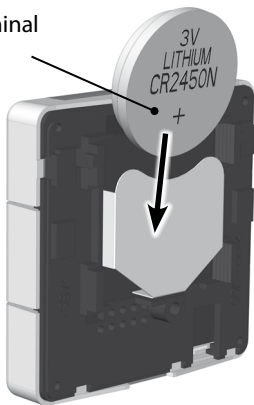

A software reset must be carried out to reset the DuoFern Multiple Wall Controller to the original default condition as when supplied.

1.

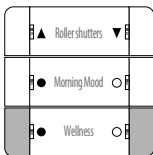

Press and hold buttons 5 and 6 simultaneously until all LEDs continuously light up red.

2. All settings have been erased and reset to the default factory settings. All of the registered DuoFern devices are automatically logged-off.

## 14. Dismantling

1. Carry out a software reset to log off all DuoFern devices from the DuoFern Multiple Wall Controller.
2. Carefully pull the operating unit and then the frame out of the wall bracket.
3. Remove the wall bracket from the wall.
4. If required, remove the battery from the DuoFern Multiple Wall Controller.



DELTA DORE RADEMACHER GmbH hereby declares that the DuoFern Multiple Wall Controller 9494-1 complies with the Directive **2014/53/EU (Radio Equipment Directive)**.

The full text of the declaration of conformity is available at the following website:

[www.rademacher.de/ce](http://www.rademacher.de/ce)

### **Warranty terms and conditions**

---

Information on our warranty conditions is enclosed separately with this product.







## 16. Cut out label insert

EN

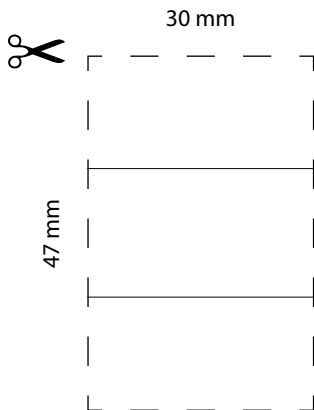

**DELTA DORE RADEMACHER GmbH**

Buschkamp 7

46414 Rhede (Germany)

Subject to technical modifications, misprints and errors excepted. Illustrations not binding.